

Data Sheet



Article number: 231111221

Description: E+G Column level indicator
HCL-400-M12

Measures

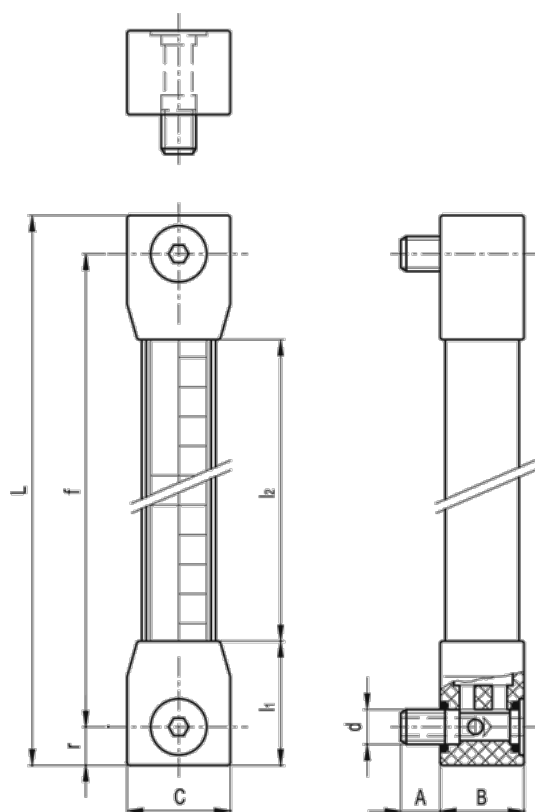

A = 13.5

r = 13

B = 28.5

Weight (g) = 268

C = 35

d = M12

f = 400

L = 426

l1 = 42

l2 = 342